

# TEKNIC

CE 

Control and Signaling Devices Ø 22.5 Clip on Plastic Series



## Control and signaling devices Ø 22.5 P4 Clip on series

### Salient features

This range of Ø 22.5 P4 Clip on series pushbuttons, selector switches, illuminated switches and pilot lights in engineering plastic construction have been designed to provide the following salient features:

- Economy of space
- Aesthetically elegant
- Robust in materials of construction
- Simple to fix-Snap fitting
- Safe in operation
- Fixing method unaffected by excessive vibration unit does not rotate
- Very good flame resistance
- Shrouded terminals
- Protection against electrical shock

### Actuators

The circular actuators have black plastic bezels, and are functionally interchangeable on the different types of contact elements.

### Contact elements

The contact elements are double break. The elements are interchangeable & can be stacked without additional hardware. 1 to 6 elements (NO or NC) can be used with non illuminated actuators, whereas, 1 to 4 elements (NO or NC) can be used for illuminated actuators. **Gold plated NO and NC contact elements for low voltage, low current switching circuits, < 25 mA, are available. Base mounting elements are also available.**

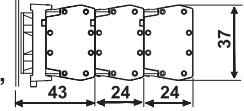

### Illuminated pushbuttons & pilot lights

Pilot lights and illuminated switches are suitable for direct connection using bayonet cap multi chip LED bulb (with OAL max 28 mm). Supply voltage using Multichip Led Bulb ..... : 12V-230 VAC / DC

Pilot lights and illuminated actuators are available with LED bulbs suitable for operating at various voltages namely 12V, 24V, 110V and 230V AC/DC.

### Terminals

Contact elements and pilot lights are designed to have shrouded terminals with combi screws.

### Fixing

The Ø 22.5 P4 Clip on series control devices can be fixed in any position on panels of 1 to 5 mm thickness.

We recommend minimum fixing centres of 30mm X 40mm. However, the dimensions and configuration should be decided on the basis of the application.

The actuators, and the lense assemblies snap fit on the holding bracket.

Details of the assembly shown in diagram.

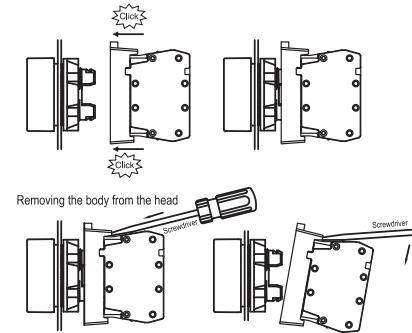
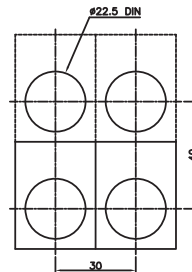

### Electrical and mechanical characteristics

#### Environment

Standards conformity	:	UL 508, EN 60947-5-1
Approvals	:	UL 508
Degree of protection	:	IP 65 as per IEC 60529, NEMA 4X, 12 as per UL 50
Ambient	:	- 25°C to + 70°C
Operating position	:	All positions
Pollution Degree	:	3

#### Contact Block

Rated insulation voltage	:	500 V																		
Rated thermal current	:	10 A																		
Contact operation	:	Slow break NO or NC																		
Make and break capacity	:	AC 15 4 A , 415 V AC																		
As per IEC 60947 - 5 - 1	:	DC 13 0.5 A , 110 V DC																		
Terminal capacity	:	Maximum 2 x 1.5 mm <sup>2</sup> or 1 x 2.5 mm <sup>2</sup> .Minimum 1 x 0.5 mm <sup>2</sup>																		
Terminal marking	:	1 - 2 for NC & 3 - 4 for NO																		
Short circuit protection	:	10 A HRC cartridge fuse, rated for resistive loading at 1000 A Prospective Current																		
Mechanical life	:	Over 1 million operations																		
Electrical rating	:																			
(for 1 million operating cycles, operating at 3600 cycles per hour, load factor 0.5)	:	<table> <tr> <td>AC 15</td> <td>V</td> <td>24</td> <td>120</td> <td>230</td> <td>DC 13</td> <td>V</td> <td>24</td> <td>110</td> </tr> <tr> <td></td> <td>A</td> <td>4</td> <td>3</td> <td>2</td> <td></td> <td>A</td> <td>0.5</td> <td>0.2</td> </tr> </table>	AC 15	V	24	120	230	DC 13	V	24	110		A	4	3	2		A	0.5	0.2
AC 15	V	24	120	230	DC 13	V	24	110												
	A	4	3	2		A	0.5	0.2												
Screw clamp tightening torque	:	0.8 Nm (Nominal recommended)																		

### Modules for pilot light & illuminated switches with LED bulb (BA9S cap)

Current consumptions (applicable to all colours)

24 V AC/DC, 110 VAC & 240 VAC	:	max. 20 mA
Terminal capacity	:	Maximum 2 x 1.5 mm <sup>2</sup> or 1 x 2.5 mm <sup>2</sup> . Minimum 1 x 0.5 mm <sup>2</sup>
Service life (at nominal voltage and at ambient temperature at 25°C)	:	100,000 hours

# TEKNIC

Control & Signalling Devices 22.5 Ø  
P4 Clip on Plastic Series

MOMENTARY ACTUATORS			
	TYPE	COLOUR	ORDERING CODE
		White	P4AF1
		Black	P4AF2
	Flush	Green	P4AF3
		Red	P4AF4
		Blue	P4AF6
		Yellow	P4AF8
			
	Flush with Arrow marking	White	P4AF1BA
		Black	P4AF2WA
		White	P4AP1
		Black	P4AP2
	Projecting	Green	P4AP3
		Red	P4AP4
		Blue	P4AP6
		Yellow	P4AP8
		White	P4AF1RR
		Black	P4AF2RR
	Flush Relay Reset	Green	P4AF3RR
		Red	P4AF4RR
		Blue	P4AF6RR
		Yellow	P4AF8RR
		White	P4AF1+2BT7
		Black	P4AF2+2BT7
	Booted	Green	P4AF3+2BT7
		Red	P4AF4+2BT7
		Blue	P4AF6+2BT7
		Yellow	P4AF8+2BT7

# TEKNIC

Control & Signalling Devices 22.5 Ø

P4 CLIP ON PLASTIC SERIES

STOP MUSHROOM HEAD ACTUATORS			
	TYPE	COLOUR	ORDERING CODE
			
	Push Pull	Black	P4AMPP4
	Ø 40 mm	Red	P4AMPP4
			
	Latching	Black	P4AMLS2
	Ø 30mm	Red	P4AMLS4
			
	Latching	Black	P4AML2
	Ø 40mm	Red	P4AML4
			
	Latching with Key	Black	P4AMLKB2
	Ø 40mm	Red	P4AMLKB4
			
	Push Pull	Black	P4AMPPJ2
	Ø 60 mm	Red	P4AMPPJ4
			
	Latching	Black	P4AMLJ2
	Ø 60mm	Red	P4AMLJ4

# TEKNIC



Control & Signalling Devices 22.5 Ø

## P4 CLIP ON PLASTIC SERIES

MUSHROOM HEAD ACTUATORS			
	TYPE	COLOUR	ORDERING CODE
		Black	P4AM2
	Momentary	Green	P4AM3
	Ø 40mm	Red	P4AM4
		Blue	P4AM6
		Yellow	P4AM8
	Momentary	Black	P4AMJ2
	Ø 60mm	Green	P4AMJ3
		Red	P4AMJ4
		Blue	P4AMJ6
		Yellow	P4AMJ8
EMERGENCY STOP MUSHROOM HEAD ACTUATORS			
	TYPE	COLOUR	ORDERING CODE
			
	Trigger type	Black	P4AMLT2
	Press to Lock	Red	P4AMLT4
	turn to release		
	Ø 40 mm		
			
	Trigger type	Black	P4AMLTKB2
	Press to Lock	Red	P4AMLTKB4
	key to release		
	Ø 40 mm		

# TEKNIC

Control & Signalling Devices 22.5 Ø  
P4 Clip on Plastic Series

SELECTOR ACTUATORS				
	TYPE	COLOUR	ORDERING CODE	
	2 position STAY PUT	Black	P4AS2-2P	
	with extended knob			P4AS2E-2P
	2 position MOMENTARY	Black	P4AS2-2PSR	
	with extended knob			P4AS2E-2PSR
		3 position STAY PUT	Black	P4AS2-3P
		with extended knob		
3 position MOMENTARY on both sides		Black	P4AS2-3PSR	
with extended knob				P4AS2E-3PSR
3 position MOMENTARY on right		Black	P4AS2-3PSRR	
with extended knob				P4AS2E-3PSRR
3 position MOMENTARY on left	Black	P4AS2-3PSRL		
with extended knob			P4AS2E-3PSRL	



# TEKNIC

Control & Signalling Devices 22.5 Ø

P4 Clip on Plastic Series



## KEY SELECTOR ACTUATORS



TYPE	COLOUR	ORDERING CODE
2 Position Stayput	Black	P4AK2-2PB
		P4AK2-2PO
		P4AK2-2PI
Spring Return	Black	P4AK2-2POSR
3 Position Stayput	Black	P4AK2-3PA
	Black	P4AK2-3PB
	Black	P4AK2-3PC
Spring Return	Black	P4AK2-3PSR
Spring Return right to centre	Black	P4AK2-3PSRR
Spring Return left to centre	Black	P4AK2-3PSRL
<b>X stands for position in which key is removable</b>		

# TEKNIC

Control & Signalling Devices 22.5 Ø  
P4 Clip on Plastic Series

TWIN ACTUATORS			
	TYPE	COLOUR	ORDERING CODE
	Double Flush	Green	P4ATF3F4
	w/o IO Mark	Red	
	Double Flush	Green	P4ATF3F4(IO)
	with IO Mark	Red	
	1 Flush,	Green	P4ATF3P4
	1 Projecting	Red	
	w/o IO Mark		
	1 Flush,	Green	P4ATF3P4(IO)
	1 Projecting	Red	
	with IO Mark		



# TEKNIC

**Control & Signalling Devices 22.5 Ø**  
**P4 Clip on Plastic Series**

<b>ILLUMINATED MOMENTARY ACTUATORS WITH LED BULB</b>			
	TYPE	COLOUR	ORDERING CODE
<b>Illuminated Flush, Momentary</b>			
			
	LED Bulb, BA9S type	White LED Bulb / White Lens	P4ALF1LB(S)
	24V AC/DC,	Green LED Bulb / Green Lens	P4ALF3LB
	110VAC, 110VDC	Red LED Bulb / Red Lens	P4ALF4LB
	230VAC, 220VDC	Amber LED Bulb / Amber Lens	P4ALF5LB
		Blue LED Bulb / Blue Lens	P4ALF6LB
		White LED Bulb / Clear Lens	P4ALF7LB(S)
		Yellow LED Bulb / Yellow Lens	P4ALF8LB
Please mention the voltage required after the ordering code			
<b>Illuminated Projecting, Momentary</b>			
			
	LED Bulb, BA9S type	White LED Bulb / White Lens	P4ALF1LB(S)
	24V AC/DC,	Green LED Bulb / Green Lens	P4ALF3LB
	110VAC, 110VDC	Red LED Bulb / Red Lens	P4ALF4LB
	230VAC, 220VDC	Amber LED Bulb / Amber Lens	P4ALF5LB
		Blue LED Bulb / Blue Lens	P4ALF6LB
		White LED Bulb / Clear Lens	P4ALF7LB(S)
		Yellow LED Bulb / Yellow Lens	P4ALF8LB
Please mention the voltage required after the ordering code			

# TEKNIC

Control & Signalling Devices 22.5 Ø  
P4 Clip on Plastic Series





ILLUMINATED SELECTOR WITH LED BULB			
	TYPE	COLOUR	ORDERING CODE
	<b>2 Position, Illuminated selector actuator</b>		
	<b>Stayput Type</b>	White LED Bulb / White Lens	P4ASL1LB(S)-2P
		Green LED Bulb / Green Lens	P4ASL3LB2P
	<b>LED Bulb BA9S type</b>	Red LED Bulb / Red Lens	P4ASL4LB-2P
	<b>24V AC/DC,</b>	Amber LED Bulb / Amber Lens	P4ASL5LB2P
	<b>110VAC, 110VDC</b>	Blue LED Bulb / Blue Lens	P4ASL6LB-2P
	<b>230VAC, 220VDC</b>	White LED Bulb / Clear Lens	P4ASL7LB(S)-2P
		Yellow LED Bulb / Yellow Lens	P4ASL8LB-2P
	Please mention the voltage required after the ordering code		
	<b>Spring Return</b>	White LED Bulb / White Lens	P4ASL1LB(S)-2PSR
		Green LED Bulb / Green Lens	P4ASL3LB2PSR
	<b>LED Bulb BA9S type</b>	Red LED Bulb / Red Lens	P4ASL4LB-2PSR
	<b>24V AC/DC,</b>	Amber LED Bulb / Amber Lens	P4ASL5LB2PSR
	<b>110VAC, 110VDC</b>	Blue LED Bulb / Blue Lens	P4ASL6LB-2PSR
	<b>230VAC, 220VDC</b>	White LED Bulb / Clear Lens	P4ASL7LB(S)-2PSR
	Yellow LED Bulb / Yellow Lens	P4ASL8LB-2PSR	
Please mention the voltage required after the ordering code			

# TEKNIC

Control & Signalling Devices 22.5 Ø

P4 Clip on Plastic Series

## ILLUMINATED SELECTOR WITH LED BULB

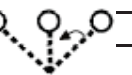
	TYPE	Colour of LED / Lens	ORDERING CODE
<b>3 Position, Illuminated Selector Actuator</b>			
	<b>Stayput type</b>		
	LED Bulb	White LED Bulb / White Lens	P4ASL1LB(S)-3P
	BA9S type	Green LED Bulb / Green Lens	P4ASL3LB-3P
	24V AC/DC, 	Red LED Bulb / Red Lens	P4ASL4LB-3P
	110VAC, 110VDC	Amber LED Bulb / Amber Lens	P4ASL5LB-3P
	230VAC, 220VDC	Blue LED Bulb / Blue Lens	P4ASL6LB-3P
		White LED Bulb / Clear Lens	P4ASL7LB(S)-3P
		Yellow LED Bulb / Yellow Lens	P4ASL8LB-3P
	<b>Please mention the voltage required after the ordering code</b>		
	<b>Spring return both sides</b>		
	LED Bulb	White LED Bulb / White Lens	P4ASL1LB(S)-3PSR
	BA9S type	Green LED Bulb / Green Lens	P4ASL3LB-3PSR
	24V AC/DC, 	Red LED Bulb / Red Lens	P4ASL4LB-3PSR
	110VAC, 110VDC	Amber LED Bulb / Amber Lens	P4ASL5LB-3PSR
	230VAC, 220VDC	Blue LED Bulb / Blue Lens	P4ASL6LB-3PSR
		White LED Bulb / Clear Lens	P4ASL7LB(S)-3P
		Yellow LED Bulb / Yellow Lens	P4ASL8LB-3PSR
	<b>Please mention the voltage required after the ordering code</b>		
<b>Spring return left to centre</b>			
LED Bulb	White LED Bulb / White Lens	P4ASL1LB(S)-3PSRL	
BA9S type	Green LED Bulb / Green Lens	P4ASL3LB-3PSRL	
24V AC/DC, 	Red LED Bulb / Red Lens	P4ASL4LB-3PSRL	
110VAC, 110VDC	Amber LED Bulb / Amber Lens	P4ASL5LB-3PSRL	
230VAC, 220VDC	Blue LED Bulb / Blue Lens	P4ASL6LB-3PSRL	
	White LED Bulb / Clear Lens	P4ASL7LB(S)-3PL	
	Yellow LED Bulb / Yellow Lens	P4ASL8LB-3PSRL	
<b>Please mention the voltage required after the ordering code</b>			
<b>Spring return right to centre</b>			
BA9S type 	Green LED Bulb / Green Lens	P4ASL3LB-3PSRR	
24V AC/DC,	Red LED Bulb / Red Lens	P4ASL4LB-3PSRR	
110VAC, 110VDC	Amber LED Bulb / Amber Lens	P4ASL5LB-3PSRR	
230VAC, 220VDC	Blue LED Bulb / Blue Lens	P4ASL6LB-3PSRR	
	White LED Bulb / Clear Lens	P4ASL7LB(S)-3PR	
	Yellow LED Bulb / Yellow Lens	P4ASL8LB-3PSRR	
<b>Please mention the voltage required after the ordering code</b>			

# TEKNIC

Control & Signalling Devices 22.5 Ø  
P4 Clip on Plastic Series

<b>TWIN ILLUMINATED ACTUATORS WITH LED BULB</b>			
	TYPE	COLOUR	ORDERING CODE
	<b>Twin Illuminated Flush/Flush Actuator with IO Marked</b>		
	LED Bulb, BA9S type	Green Flush Actuator	
	24V AC/DC,	Red Flush Actuator	P4ATL5LBF3F4 (IO)
	110VAC, 110VDC	Amber Lens / Amber LED	
	230VAC, 220VDC		
	<b>Please mention the voltage required after the ordering code</b>		
	<b>Twin Illuminated Flush/Projecting Actuator IO Marked</b>		
	LED Bulb BA9S type	Green Flush Actuator	
	24V AC/DC,	Red Flush Actuator	P4ATL5LBF3P4 (IO)
	110VAC, 110VDC	Amber Lens / Amber LED	
230VAC, 220VDC			
<b>Please mention the voltage required after the ordering code</b>			

# TEKNIC

Control & Signalling Devices 22.5 Ø  
P4 Clip on Plastic Series

EMERGENCY STOP MUSHROOM ILLUMINATED ACTUATORS, LATCHING, WITH LED BULB			
	TYPE	COLOUR	ORDERING CODE
	<b>Mushroom Illuminated Actuator, Trigger Type, Press to Lock - Turn to release</b>		
			
	LED Bulb, BA9S type		
	24V AC/DC,	Red	P4ALMLT4LB
	110VAC, 110VDC		
	230VAC, 220VDC		
Please mention the voltage required after the ordering code			

# TEKNIC



Control & Signalling Devices 22.5 Ø

P4 Clip on Plastic Series

PILOT LIGHTS WITH LED BULB			
	TYPE	COLOUR	ORDERING CODE
	<b>Pilot Light</b>		
			
	LED Bulb, BA9S type	White LED Bulb / White Lens	P4PLB1LB(S)
	24V AC/DC,	Green LED Bulb / Green Lens	P4PLB3LB
	110VAC, 110VDC	Red LED Bulb / Red Lens	P4PLB4LB
	230VAC, 220VDC	Amber LED Bulb / Amber Lens	P4PLB5LB
		Blue LED Bulb / Blue Lens	P4PLB6LB
		White LED Bulb / Clear Lens	P4PLB7LB(S)
		Yellow LED Bulb / Yellow Lens	P4PLB8LB
	Please mention the voltage required after the ordering code		



# TEKNIC

## Control & Signalling Devices 22.5 Ø P4 Clip on Plastic Series

CONTACT ELEMENTS		
	TYPE	ORDERING CODE
 <p>Green TEKNIC C1 contact element with 3 contacts (1 NO, 2 NC). Technical specifications: AC 15: 415V, 4A; DC 15: 110V, 0.5A.</p>	<b>PANEL MOUNTING</b>	
	NORMALLY OPEN SILVER CONTACTS	C1
	NORMALLY CLOSED SILVER CONTACTS	C2
	NORMALLY OPEN GOLD CONTACTS	C3
	NORMALLY CLOSED GOLD CONTACTS	C4
	<b>BASE MOUNTING</b>	
	NORMALLY OPEN SILVER CONTACTS	C5
	NORMALLY CLOSED SILVER CONTACTS	C6
	NORMALLY OPEN GOLD CONTACTS	C7
	NORMALLY CLOSED GOLD CONTACTS	C8
 <p>Red TEKNIC C2 contact element with 2 contacts (1 NO, 1 NC). Technical specifications: AC 15: 415V, 4A; DC 15: 110V, 0.5A.</p>		

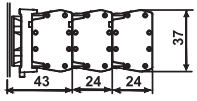
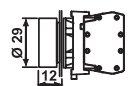
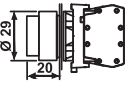
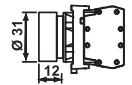
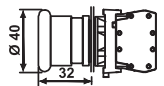
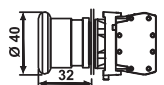
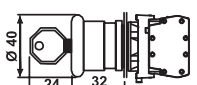

## Common types of control and signalling devices Ø 22.5 P4 Clip on series

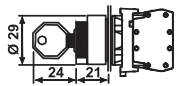
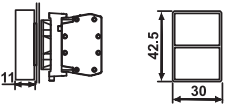
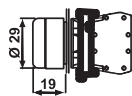
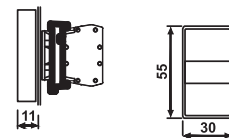
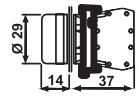
Description	Type of Actuator or Lense Assembly	Colour of Actuator or Lense	Contact Elements NO = C1 NC = C2 or Lamp Holder	Type of complete Control or Signalling Device	
Flush Pushbutton	P4AF3	Green	1NO	P4PSF310	
	P4AF8	Yellow	2NO+1NC	P4PSF821	
Projecting Pushbutton	P4AP2	Black	2NC	P4PSP202	
	P4AP4	Red	3NO+3NC	P4PSP433	
Booted Pushbutton	P4AF3+2BT7	Green + clear boot	2NO	P4PSF320+2BT7	
	P4AF4+2BT7	Red + clear boot	2NC	P4PSF402+2BT7	
Mushroom Pushbutton Spring return	P4AM2	Black	1NO+1NC	P4PSM211	
	P4AM4	Red	1NC	P4PSM401	
Mushroom Pushbutton latching turn to release	P4AML2	Black	1NC	P4PSML201	
	P4AML4	Red	2NO+2NC	P4PSML422	
Mushroom Pushbutton latching, key to release	P4AMLKB4	Red	1NO+1NC	P4PSMLKB411	
Selector Actuator (2 Pos)	P4AS2-2P	Black	1NO	P4PSS210-2P	
Selector Actuator (3 Pos)	P4AS2-3P	Black	1NO+1NC	P4PSS211-3P	
Key Actuator (2 Pos), key removable in both positions Key Actuator (3 Pos), key removable in left & right positions	P4AK2-2PB		1NO	P4PSK210-2PB	
	P4AK2-3PB		1NO+1NC	P4PSK211-3PB	
Twin Pushbutton marked "I O"	P4ATF2-F4-IO	Flush-Green	1 NO	P4PSTF310-F401-IO	
Flush - Flush		Flush-Red	1 NC		
Flush Illuminated Pushbutton with multichip LED bulb, direct connection	P4ALF3LB24DC	Green	1NO+1NC	P4PSLF3LB1124	
Twin Luminous Pushbutton Without "I O"making Flush - Flush with LED Bulb (240V AC)	P4ATL5LB-F3 -F4230AC	Lense-Amber Flush-Green Flush-Red	1 NO 1 NC	P4PSTL5LBF310-F401230AC	
Pilot Light with LED bulb for 230V AC Bulb: 230V	P4PLLA5	Amber	4LHLB230	P4PLB5LB230	

# TEKNIC

703, Madhava, Bandra Kurla Complex, Bandra East, Mumbai-400 051. Tel.: (022) 42532500. Email : teknic@tekninc.com Website : www.tekninc.co.in

April 2019

CH:MT:07  
REV:A